

**300X300mm SIDE WALK (PAVEMENT) BLOCK**  
DESIGNED TO BE PLACED IN SIDE WALK

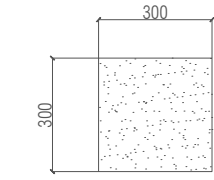

PLAN  
SCALE 1:20

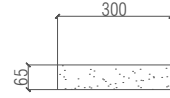

ELEVATION  
SCALE 1:20

**CURB STONE (BIG)**  
CHAMFER

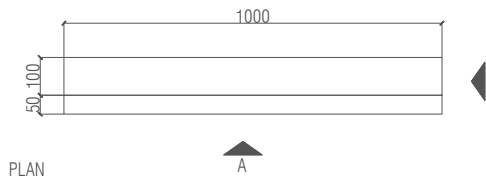

PLAN  
SCALE 1:20

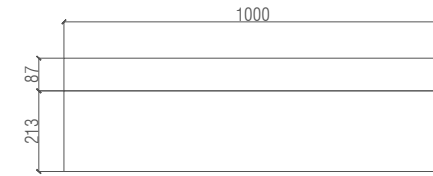

ELEVATION - A  
SCALE 1:20

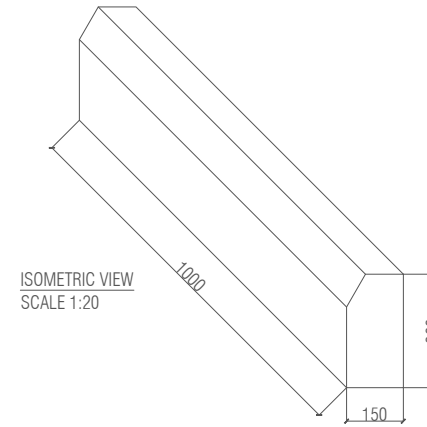

ISOMETRIC VIEW  
SCALE 1:20

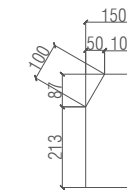

ELEVATION - B  
SCALE 1:20

**300X300mm PERFORATED BLOCK**  
DESIGNED TO BE PLACED IN TREE PIT AREA

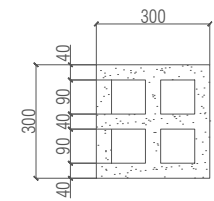

PLAN  
SCALE 1:20

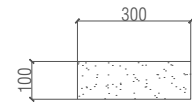

ELEVATION  
SCALE 1:20

**CURB STONE (SMALL)**  
CHAMFER

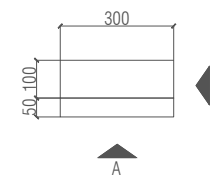

PLAN  
SCALE 1:20

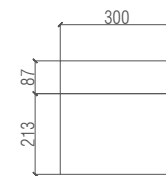

ELEVATION - A  
SCALE 1:20

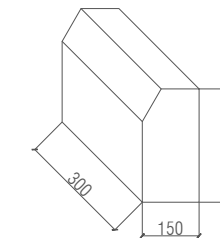

ISOMETRIC VIEW  
SCALE 1:20

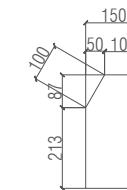

ELEVATION - B  
SCALE 1:20



ROAD DEVELOPMENT COOPERATION

ORCHID MAGU MALE'

LEGENDS:

PROJECT:  
DESIGN & BUILD OF GA.MAAMENDHOO MAJOR ROADS

DRAWING TITLE:  
GRASS BLOCK, PAVEMENT BLOCK & CURBSTONE DETAILS

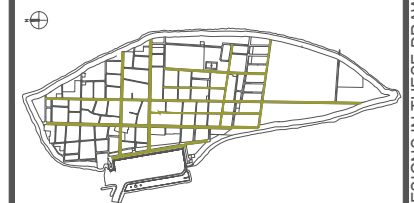

ISLAND MAP  
NOT TO SCALE

DRAWN BY	MOHAMED RUSHDHAN
APPROVED BY	ALI ZAMEER
DATE:	PAGE NO:

SCALE: AS GIVEN	19
-----------------	----

COPYRIGHT: THE CONCEPT & DESIGNS IN THESE DRAWINGS ARE PROPERTIES OF RDC. UNAUTHORIZED USE OF ANY KIND OR COPY OF THESE DRAWINGS ARE STRICTLY PROHIBITED